

Zolder bestand

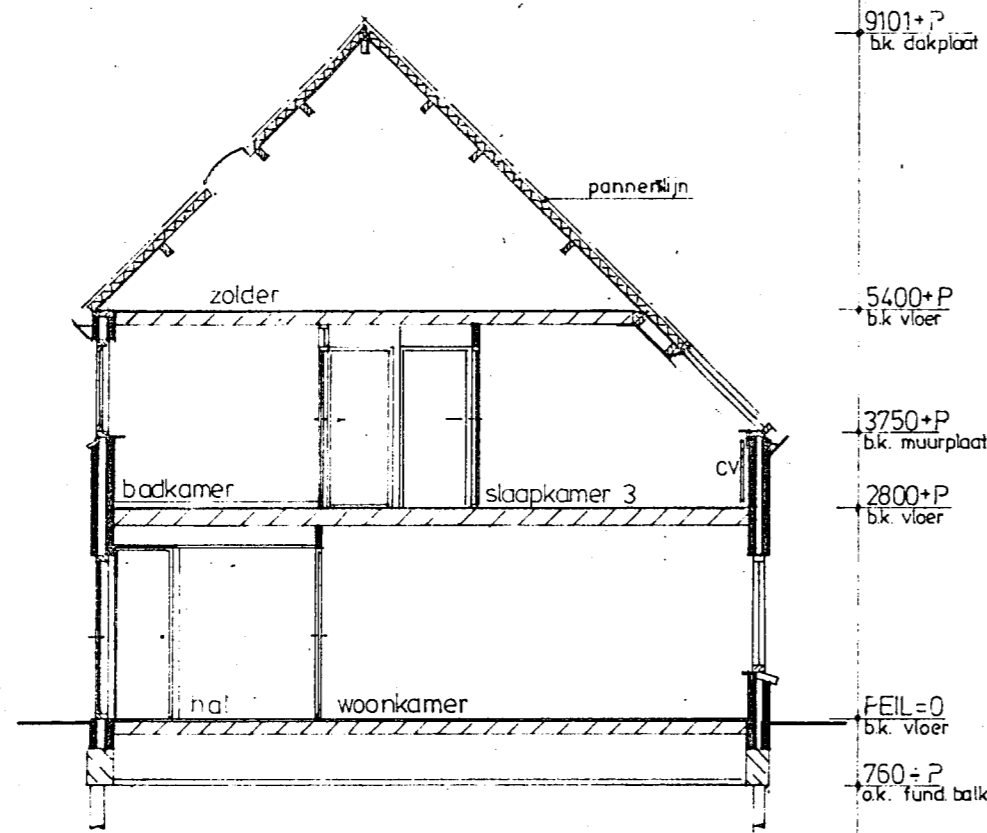

Doorsnede bestand

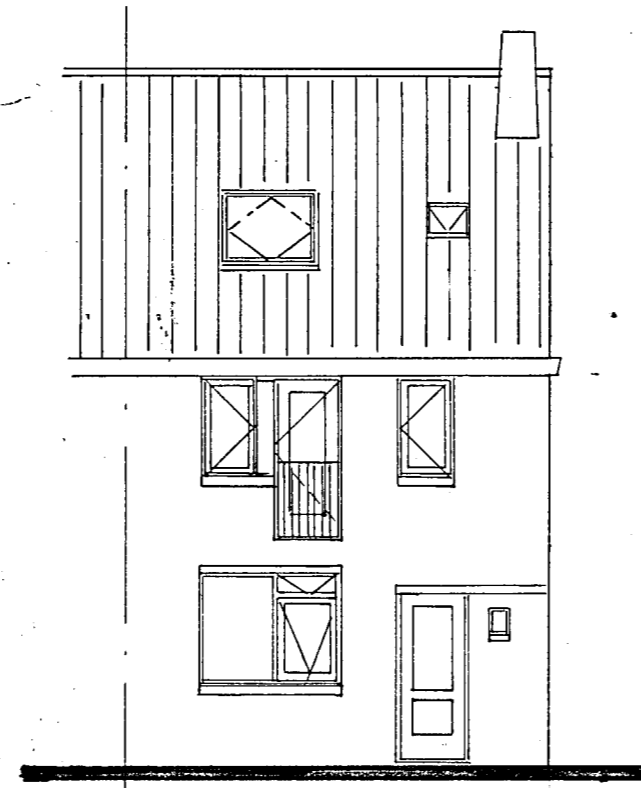

Voorgevel bestand

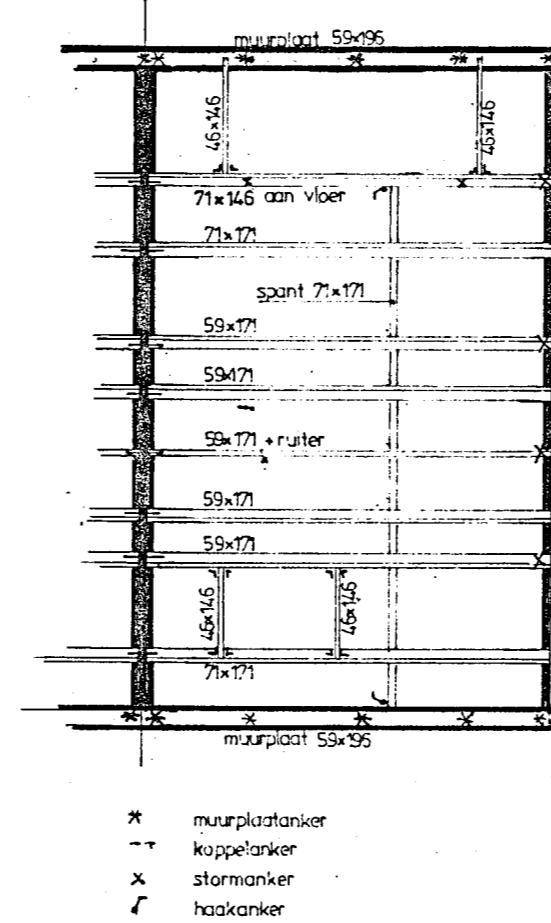

Kapplan bestand

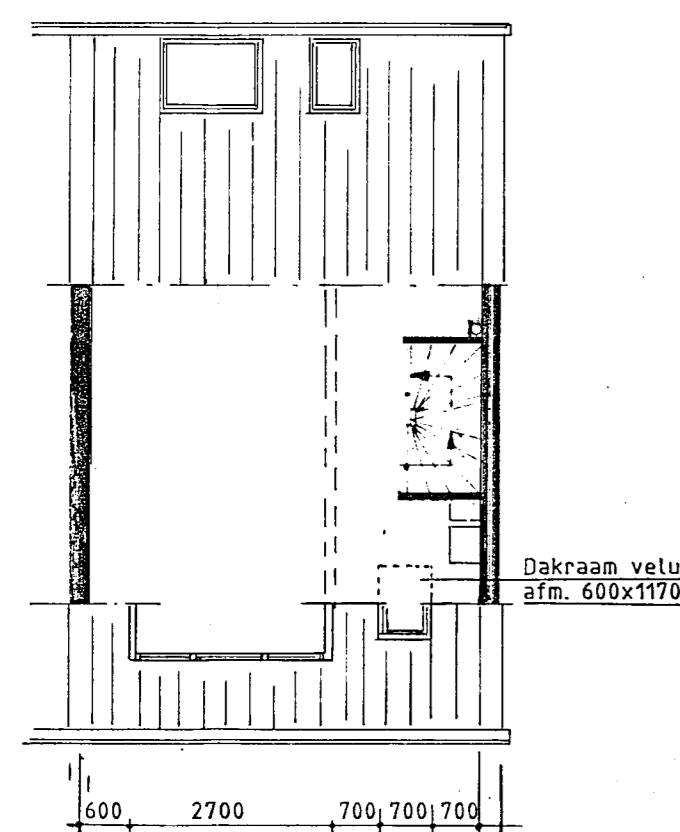
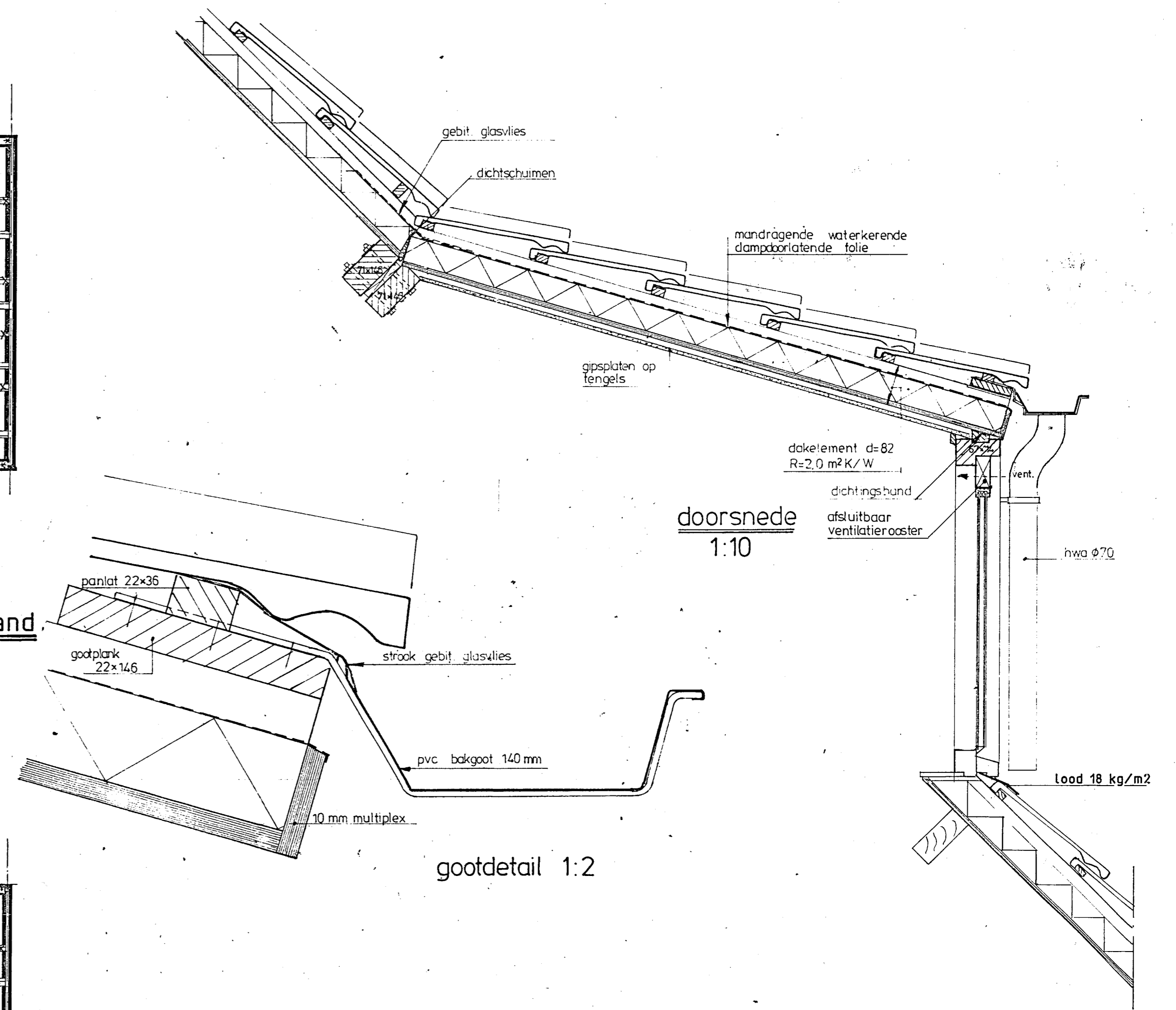

Zolder nieuw

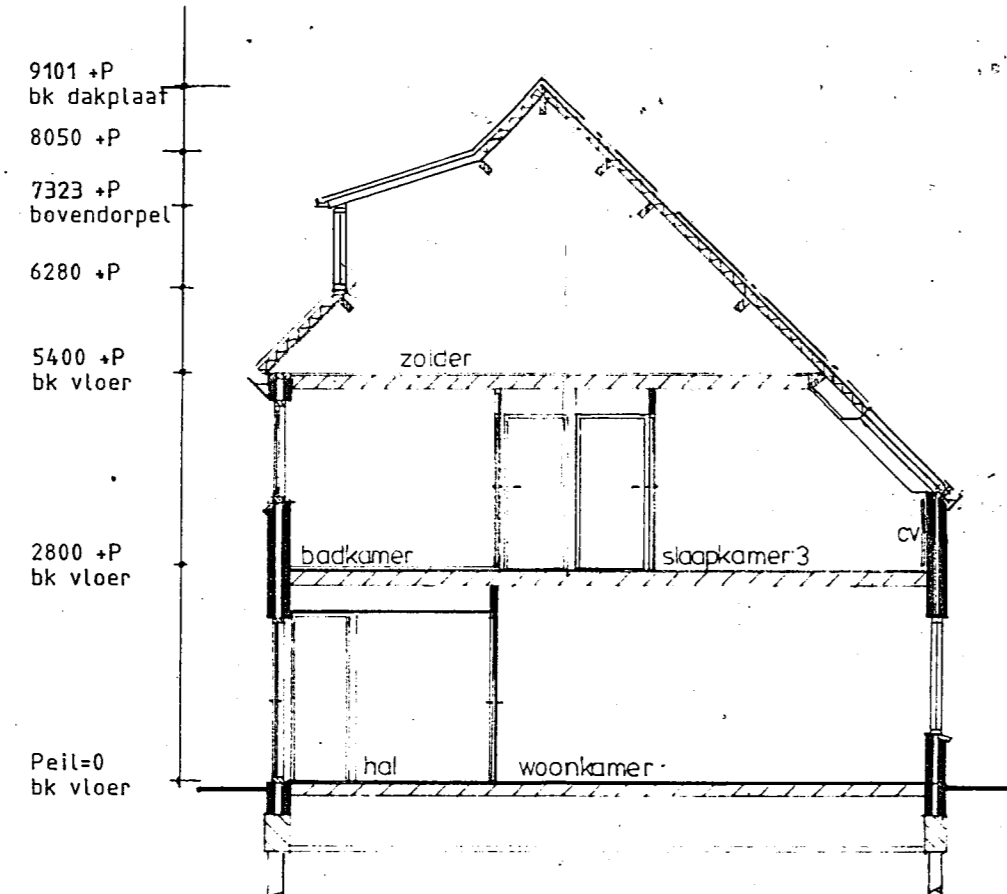

Doorsnede nieuw

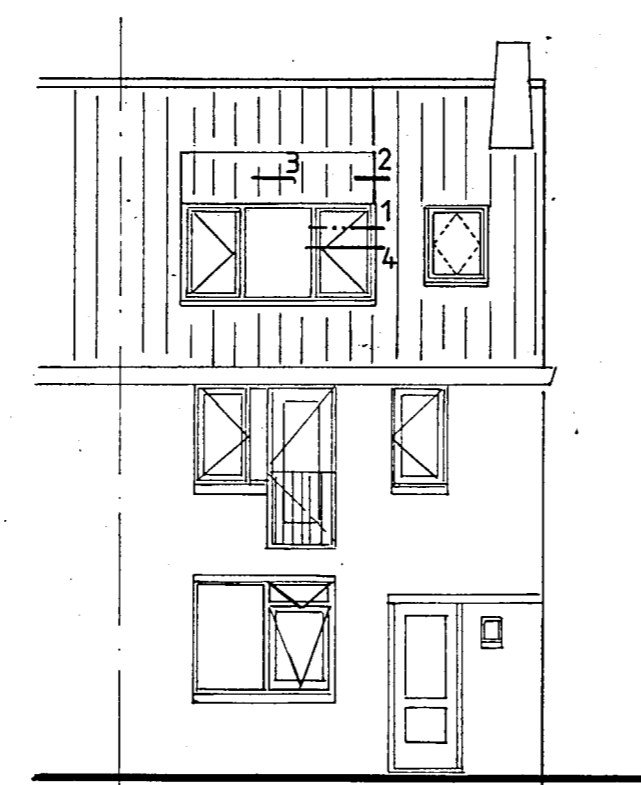

Voorgevel nieuw

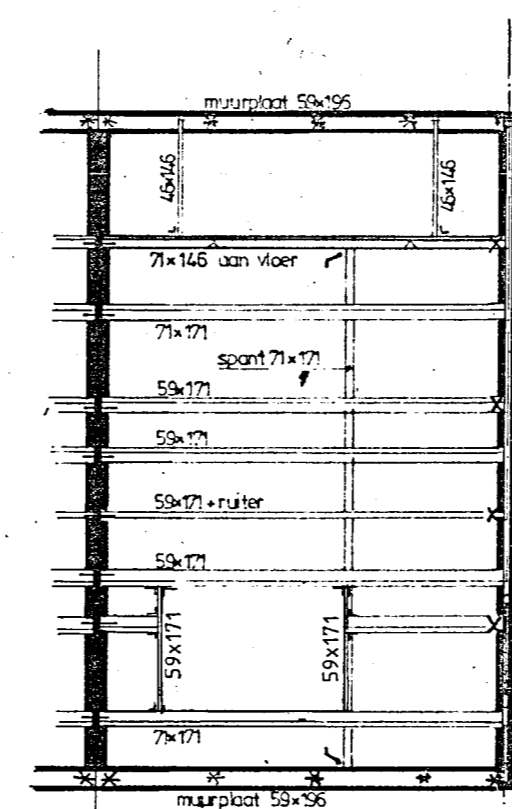

Kapplan nieuw

Behoort bij besluit van  
B. en W. van Heemskerk  
dd. 13 SEP. 1994 no. 132  
Mij bekend. 1994  
De Secretaris van Heemskerk.

*H. Heemskerk*

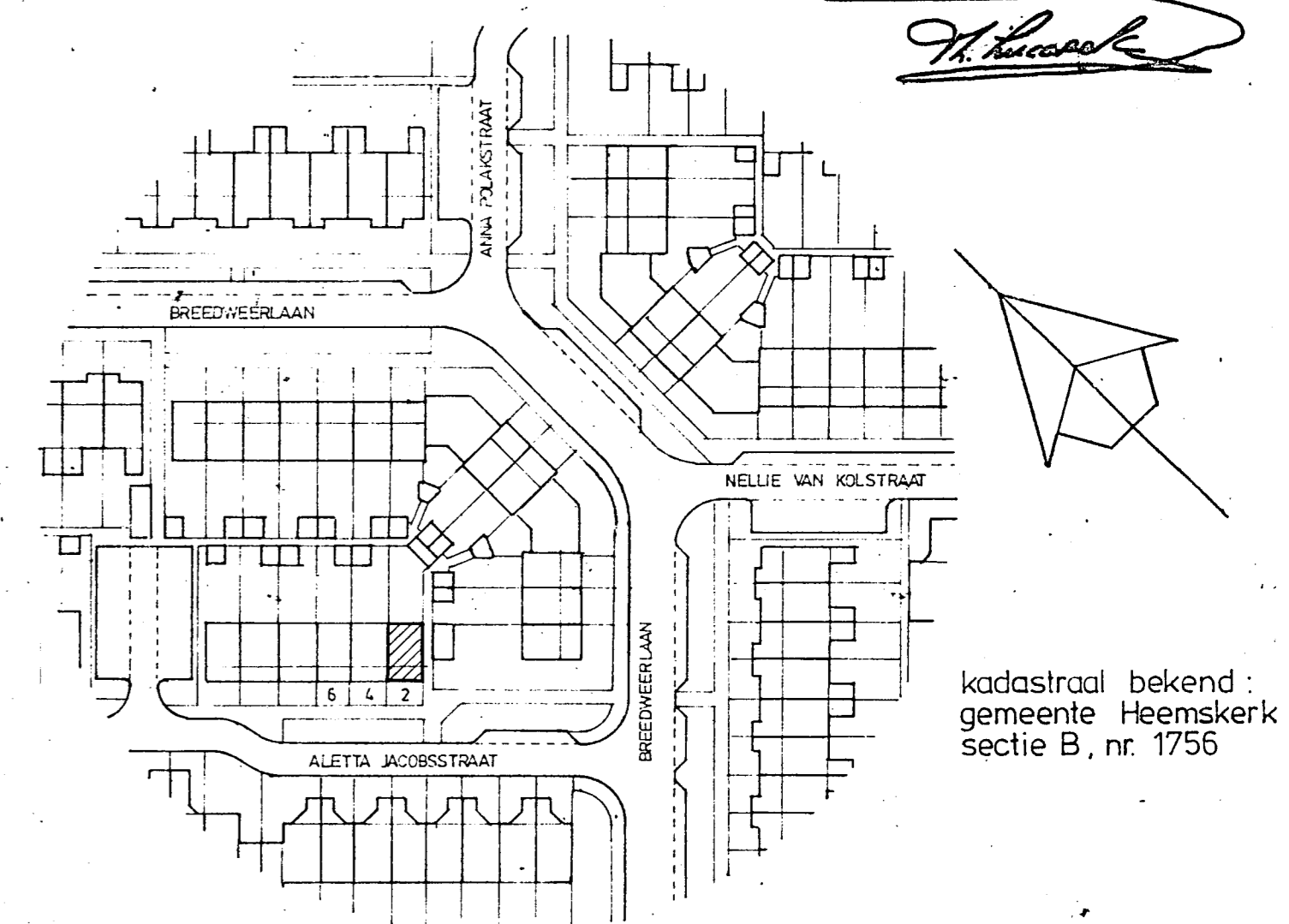

kadastraal bekend  
gemeente Heemskerk  
sectie B, nr. 1756

INGEKOMEN 8 AUG. 1994

project: woonhuis gelegen aan de A. Jacobsstr. 2 te Heemskerk van S. Sjoerdsma

onderwerp aanvraag voor het mogen plaatsen van een dakkapel **voorgevel**

schaal 1:100 1:5	getekend HG 15/04/94	gevestigd c b	formaat A1	project nr. 94-2
------------------------	----------------------------	---------------------	---------------	---------------------

